

Article number: 203180M24200B2TK
 Description: E+G levelling foot
 GN 31-80-M24-200-B2-TK
 Note: TK With nut, Wrench flat at the bottom

Measures

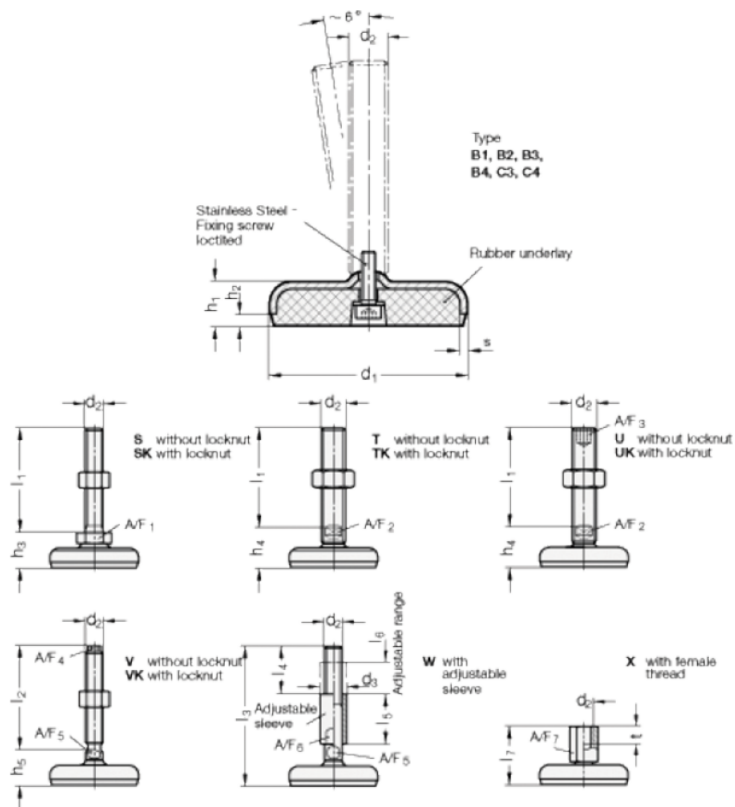

A/F2	= 19
d1	= 80
d2	= 24
h1	= 18
h2	= 5
h4 +4.0/0	= 36
l2	= 200
s	= 3